

SANYO

INSTRUCTION MANUAL

DVD-DX517

DVD Player



Contents

Features.....	2
For your Attention.....	3
Package Contents.....	4
Panel.....	5
Remote Control.....	6-7
Remote Control Function.....	8-9
Connections.....	10-11
System Setup.....	12-17
Basic Playback.....	18-19
Troubleshooting.....	20
Specifications.....	21

Features

Thanks for your purchase of our product. Please read through this manual before making connections and operating this product. Retain this manual for future reference.

DVD player is a domestic video player of new generation which produces high quality pictures and Hi-Fi audio effect. Its performance is much better than that of any previous home video equipment. As the best signal source , it will give you the uppermost enjoyment!

- Built-in Dolby AC-3, MPEG, PCM etc. digital audio decoder.
- Hi-Fi, 96kHz/24bit audio digital processor.
- Software intelligent upgrade.
- High-resolution component video output, support the future video equipment.
- Coaxial digital audio output.
- With USB port
- Compatible with DVD, SVCD, VCD, DVCD, CD, DVD+R/RW, DVD-R/RW, MP3, **Picture CD, etc.**
- High integrated servo system, decoding on single-chip technology, high reliability and stability, and super error- correction.



For Your Attention

IMPORTANT NOTES:

- Please read through this manual before making connections and operating this product. Retain this manual for future reference.
- Don't open the cabinet of this unit. No user-serviceable parts inside. Refer servicing to qualified personnel only.
- Switch off the unit when you don't use it. Switch off the unit and disconnect it from the AC power supply when it is not being used for a long time. (Plug, as the disconnected device entirely with power source, should keep in easy-to-operation in daily life.)
- Don't install the unit in a place exposed to heating sources or direct sunshine.
- Don't install the unit in a place exposed to moisture or rain.
- The apparatus shall not be exposed to dripping or splashing and any object filled with liquids, such as vases shall not be placed on it.
- Install the unit on a horizontal, flat and firm surface with good ventilation. Never block the vents which will cause malfunction resulting from overheating.
- Use a soft and clean cloth to clean the outside of the unit. Never clean it with chemicals or detergent.
- This book is only a guide for user's operation, not a criterion for configuration.
- Do not install this apparatus in a confined space, such as a book case or built-in cabinet. Minimum distance (about 100mm) around the apparatus for sufficient ventilation.
- To be completely disconnected the power input, the mains plug of apparatus shall be disconnected from the mains.

WARNING: The batteries shall not be exposed to excessive heat such as sunshine, fire or the like.

CAUTION: Danger of explosion if battery is incorrectly replaced. Replace only with the same or equivalent type.

	CAUTION RISK OF ELECTRIC SHOCK DO NOT OPEN	
TO REDUCE THE RISK OF ELECTRIC SHOCK OR FIRE, DO NOT OPEN THE COVER. REFER SERVICING TO QUALIFIED SERVICE PERSONNEL.		





The lightning flash is intended to alert the user to the presence of dangerous voltage within the product's enclosure, and touching the internal components may result in a risk of electric shock to persons.



The exclamation mark is intended to alert the user to the presence of important operating instructions.

CLASS 1 LASER PRODUCT
KLASS 1 LASER APPARAT
LUOKEN 1 LASER LAITE
KLASSE 1 LASER PRODUKT



SANYO	Model No.: DVD-DX517 DVD PLAYER
POWER CONSUMPTION: 20W POWER SOURCE: AC ~ 100 - 240V 50 / 60Hz	 
SANYO Electric Co., Ltd. MADE IN CHINA	

Package Contents

Package Contents

User manual









Remote control



A/V cable



Playable Disc and Media Types:

Disc types	Symbol	Contents
DVD		Audio + Video
MP3		Audio
Video-CD (VCD)	 	Audio + Video
CD-DA		Audio
Picture CD		JPEG Photo CD

DVD REGION CODES:

DVD discs and players are covered by a worldwide agreement which limits playback of DVD discs to specific regions as determined by the software manufacturer. Most DVDs come marked with a region coding. A disc specified as playable in one region may not play on a player designed for a different region. A disc specified as universal or with no region coding (Code 0) may be played in any region.

The regions are:

- Region 1: Canada, USA
- Region 2: Europe, Japan, Mid. East, South Africa
- Region 3: South-East Asia
- Region 4: Australia, Caribbean, Central & South America, New Zealand
- Region 5: Africa, Former Soviet Union, India, North Korea, Pakistan
- Region 6: China

THIS PLAYER PLAYS REGION 4 **AND UNIVERSAL (0)** DISCS.

Front Panel:

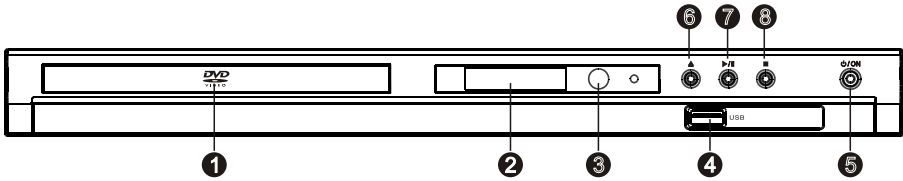

- | | |
|--------------------------|------------------------------|
| 1. Disc Tray Door | 5. Standby/ON Button(⏻ / ON) |
| 2. Display Screen | 6. Open/Close Button(▲) |
| 3. Remote Control Sensor | 7. Play/Pause Button(▶/⏸) |
| 4. USB Port | 8. Stop Button(■) |

Rear Panel:

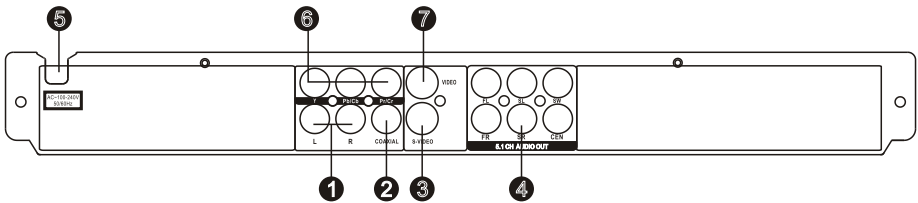

- | | |
|---------------------------------|---------------------------|
| 1. Mixed L/R Audio Output | 4. 5.1CH Audio Output |
| 2. Coaxial Digital Audio Output | 5. AC Power cord |
| 3. S-VIDEO Output | 6. Component Video Output |
| | 7. Composite Video Output |

Remote control

Remote Control Operation

Insert two AAA/1.5V batteries into the remote control. Point the remote control at the remote sensor on the front panel. The remote control works within a distance of about 7 metres from the sensor and within an angle of about 30 degrees from the left and right side.

Battery Installation

- 1 Remove the battery compartment cover on the back of the remote control.
- 2 Load the batteries into the battery compartment making sure that the batteries have been inserted with the correct polarities matching the symbols +, - as indicated inside the battery compartment.
- 3 Replace the cover.

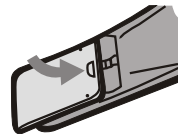
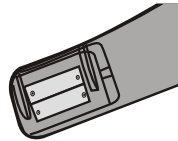
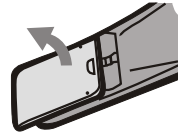

Note:

- Remove the batteries when you do not intend to use the remote control for a long time.
- Do not mix new and used batteries, or different types of batteries.
- Weak batteries can leak and severely damage the remote control.
- Be environmentally friendly and dispose of batteries according to your government regulations.

Remote control

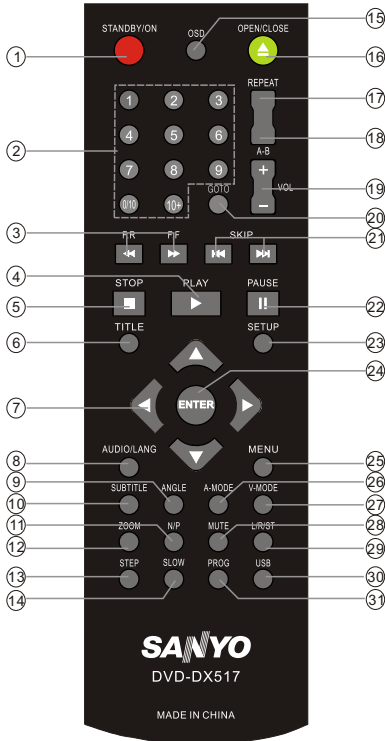

- | | |
|--------------------------------|-------------------|
| 1. STANDBY/ON | 16. OPEN/CLOSE(▲) |
| 2. DIGIT KEYS | 17. REPEAT |
| 3. FASTREWIND(◀◀) | 18. A-B REPEAT |
| 4. PLAY(▶) | 19. VOLUME+/- |
| 5. STOP(■) | 20. GOTO |
| 6. TITLE | 21. PREVIOUS(◀◀) |
| 7. DIRECTION KEYS
(↑ ↓ ←→) | 22. PAUSE(∥) |
| 8. AUDIO/LANG | 23. SETUP |
| 9. ANGLE | 24. ENTER |
| 10. SUBTITLE | 25. MENU |
| 11. N/P | 26. A-MODE |
| 12. ZOOM | 27. V-MODE |
| 13. STEP | 28. MUTE |
| 14. SLOW | 29. L/R/ST |
| 15. OSD
(on-screen display) | 30. USB |
| | 31. PROGRAM |

Remote control Function

STANDBY/ON



● Press to switch on the unit. Press it again to put the unit in standby mode.

N/P



● Press repeatedly to select a TV type, NTSC, PAL or MULTI.

OPEN/CLOSE



● Press to open/close the disc tray.



● The digit keys can be used to input numbers or make selection of a track or a chapter, etc.

ENTER



● Press to enter an item in the menu or to confirm and execute a selection.



● The direction keys can be used to move the highlight in the menu.

SETUP



● Press to enter/exit the setup menu.

GOTO



● During playback, press to enter the GOTO menu. In the menu, use the direction key [UP]/[DOWN] to select a setting item and press [ENTER] to enter the editing state, then with the digit keys input a specific track, disc time, track time, chapter, title, chapter time or title time to go to directly. Press it again to exit the GOTO menu.

PROG



● Press this button to enter/exit the program menu with which you can playback the contents of a disc in your desired order. In the program menu, use the direction keys and digit keys to make a program list, then move the highlight on **START** and press [ENTER] to start program playback. During program playback, press [PROG] to enter the program menu. Now, **STOP** is highlighted. Press [ENTER] to cancel the current program playback.



● Press to start a playback or resume the normal playback from the fast forward, fast reverse, frame by frame, slow motion playback, etc.



● Press to temporarily pause a playback. Press it again to resume the playback.



● Press for fast forward playback. The available speeds are 2X, 4X, 8X, 16X and 32X.



● Fast reverse playback. The available speeds are 2X, 4X, 8X, 16X and 32X.



● Press to return to the previous chapter/track.



● Press to skip to the next chapter/track.



● Press it once to pre stop a playback. Press [▶] to resume the playback from the pre stopped status. Press it twice to stop a playback and the disc will be reset to the starting point.

STEP



● Press repeatedly to advance the video frame by frame. Press [▶] to resume the normal playback. (Note: Applies to DVD, VCD discs, etc.)

Remote control Function

SLOW



● Press repeatedly for slow motion playback in different speeds. The available speeds are 1/2, 1/4, 1/8, 1/16 of the normal speed. Press [▶] to resume the normal playback. (Note: Applies to DVD, VCD discs, etc.)

REPEAT



● Press repeatedly to switch the repeat modes. (Note: For VCD2.0, SVCD, etc, this function is invalid when the PBC function is activated.)

A-B



● You can repeat a specific section of a disc with this button.

Press this button to mark down the starting point (A) and press it again to mark down the ending point (B). Then, the unit will playback this section over and over again. Press it for the third time to cancel A B repeat and resume to the normal playback.

Note: Points A and B must be in the same title/ track.

MUTE



● Press this button to switch off the sound temporarily. Press it again to switch it on.

VOLUME+/-



● Press [VOLUME+] to turn up the volume; press [VOLUME -] to turn down the volume.

TITLE



● Press to enter the title menu of a DVD disc.

MENU



● Press to return to the root menu.

● When playing disc encoded with PBC function, press to display the PBC menu. Press it again to disable the PBC function. (Note: DVD, VCD1.1, CD DA and MP3 disc have no PBC function.)

SUBTITLE



● Press repeatedly to switch the subtitles or switch off the subtitle function. (Note: This function only works with those discs encoded with subtitles.)

OSD



● Press repeatedly to switch or hide the relative information of the playing disc.

AUDIO/LANG



● Press repeatedly to select the available audio languages provided by the disc (for DVD).

L/R/ST



● Press repeatedly to switch the available audio channels (LEFT MONO, RIGHT MONO, MIX MONO and STEREO) provided by the disc (for VCD).

ANGLE



● Press to switch the viewing angles.

(Note: This function only works with the discs encoded with multiple camera angles.)

V-MODE



● Press repeatedly to switch the video output modes.

A-MODE



● Press to switch the audio output mode between 5.1 CHANNELS OUTPUT and STEREO OUTPUT.

ZOOM



● Press this button to zoom in/out the scene. The available zoom ratios are 1/2X, 1/3X, 1/4X, 2X, 3X and 4X. In zoomed in mode, the direction keys can be used to move the zooming center. (Note: Applies to DVD, VCD, etc.)

USB



● Press repeatedly to switch to the connected USB drive or to return to the DVD mode.

Connections

VIDEO SYSTEM CONNECTION

The following video outputs are available for this unit.

Composite Video

Use the cable with yellow plug of an AV cable to connect the composite video output of this unit to the video input of a TV/monitor.

S-Video

Use an S Video cable to connect the S Video output of this unit to the S video input of a TV/monitor.

Component Video

Use a 3 core AV cable to connect the component outputs of this unit to the corresponding inputs of a TV/monitor.

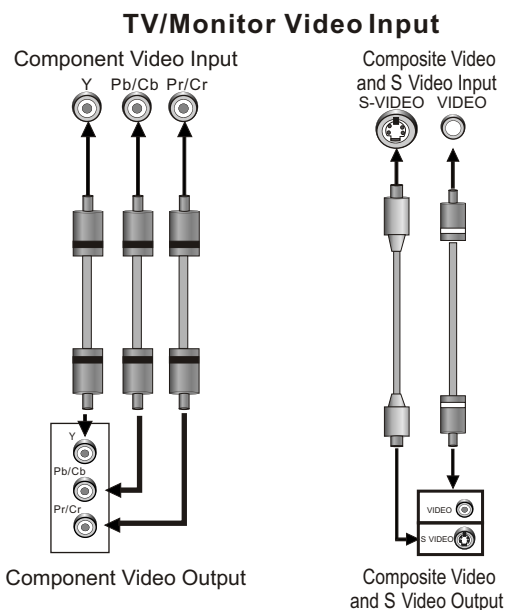

DVD Player Video Output

Notes:

- Of the video outputs above, component is the best, S VIDEO is good and the composite video is standard. Use the best available video connection.
- Don't make all the connections above at one time, otherwise the produced pictures will be affected.
- Only when the video settings conform to the actual video system connections does the player produce the corresponding video output. (Please refer to the **Video Setup in System Setup** chapter).

AUDIO SYSTEM CONNECTION

There are two types of audio output systems. They are analog audio output system and digital audio output system.

Analog audio output system includes 2 channel stereo output and Dolby AC 35.1 channel output. Digital audio output system includes coaxial output.

Stereo Audio

Use a pair of audio cable (white for left, red for right) to connect the stereo audio outputs of this unit to the stereo inputs of a TV or a power amplifier.

5.1 CH Audio

Use 3 pairs of audio cables to connect the 5.1 CH audio outputs of this unit to the 5.1 channel inputs of external audio amplifiers or other players.

Coaxial Audio

Use a coaxial cable to connect the coaxial output of this unit to the coaxial input of a power amplifier.

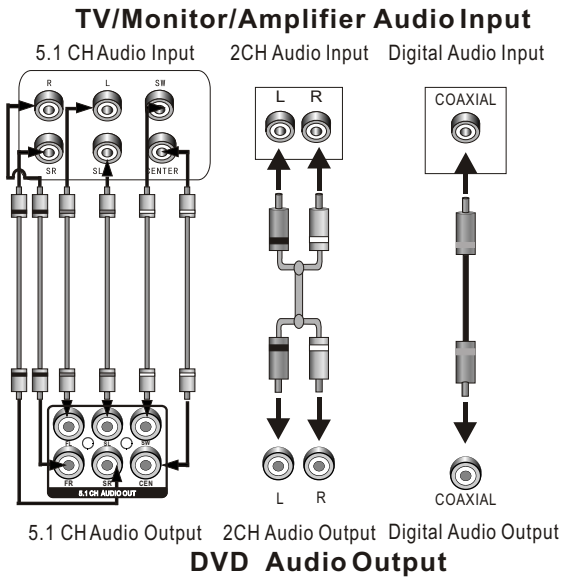

Note:

The audio settings should conform to the actual audio system connections. Please refer to the **Audio Setup** in **System Setup**.

AC POWER CONNECTION

After checking all the connections have been made correctly, plug the AC power lead of this unit into the wall socket.

NOTE:

Unplug the AC power lead from the wall socket if the unit will not be in use for a prolonged period of time.

System Setup

Menu Operation

1. Press [SETUP] on the remote control to show the setup menu.
2. Press [←]/[→] to select an item. The submenu of the selected item will be displayed below instantly.
3. Press [↑]/[↓] to select an item you desire to set in the submenu, then press [ENTER]/[→] to enter. Use [↑]/[↓] to select an option, then press [ENTER] to confirm it, or press [←] to cancel.
4. Then you can press [↑]/[↓] to continue to set other items in the submenu.
5. Press [←] to go back to the superior menu of the current one.
6. Press [SETUP] again to exit the setup menu. Alternately, move the high light to '✕', then press [ENTER] to exit the setup menu.

1 GENERAL SETUP PAGE

1.1 TV DISPLAY

If the unit is connected to a conventional TV set, you are supposed to select **4:3 PANSKAN** or **4:3 LETTERBOX**. The 4:3 image will be displayed in full screen in its native aspect ratio.

4:3 PANSKAN: The wide screen image will be displayed on the screen in its native aspect ratio with some part on the left and right cut off.

4:3 LETTERBOX: The wide screen image will be displayed in its native aspect ratio with black bands on the upper and lower sections of the screen.

16: 9: If the unit is connected to a wide screen TV set, you are supposed to select this option. The wide screen image will be displayed in full screen in its native aspect ratio while the 4:3 image will be stretched out horizontally to fit in the screen.

1.2 ANGLE MARK

Set this item to **ON**. When a disc encoded with multiple camera angles is playing, the angle mark will display on the screen. Then you can view the video of different camera angles by pressing [ANGLE] on the remote control.

Set this item to **OFF** to disable this function.

NOTE: This function only works with those discs encoded with multiple camera angles.

1.3 OSD LANGUAGE (On-Screen Display Language)

Set the on screen display language in this item.

1.4 CLOSED CAPTIONS

Set this item to **ON**. When a disc encoded with closed captions, the closed captions will be shown on the screen. Set this item to **OFF** to hide it.

You can also press [SUBTITLE] on the remote control to show or hide the closed captions.

NOTE: This function only works with those discs encoded with closed captions.

1.5 SCREEN SAVER

ON: If the image remains motionless on the screen, for example the disc is paused, stopped etc, for several minutes, a screensaver will appear on the screen. You can press any key or button except [STANDBY/ON] to wake it up.

OFF: Disable the screensaver function.

1.6 LAST MEMORY

ON: During a playback or in the paused/stopped status each time you open the disc tray or turn off the player, the unit will memorize the last playback time. Next time when you insert the same disc and close the disc tray to load the disc, the unit will play from the memorized point.

OFF: Disable the last memory function.

2 AUDIO SETUP PAGE

2.1 ANALOG AUDIO SETUP

2.1.1 DOWNMIX

LT/RT: The 5.1 channel audio is mixed into left channel and right channel and is output via the FL and FR speaker respectively.

STEREO: The 5.1 channel audio is mixed into stereo signal and is output via the FL and FR speaker.

3D SURROUND: This mode creates a virtual surround effect from stereo or multi channel audio contents.

5.1CH: Turn off the DOWNMIX mode. If the unit is connected to 5.1 channel amplifier, this item should be selected.

NOTE: This function only applies to the Dolby AC 3 encoded 5.1 channel discs.

2.1.2 FRONT, CENTER, REAR SPEAKER and SUBWOOFER

Only when the DOWNMIX mode is turned off (**DOWNMIX** is set to **5.1CH**) are the **CENTER SPEAKER** and **REAR SPEAKER** activated. The **FRONT SPEAKER** can be set to **LARGE** or **SMALL**. The **CENTER SPEAKER**, **REAR SPEAKER** can be set to **LARGE**, **SMALL** or **OFF** and the **SUBWOOFER** can be set to **ON** or **OFF**.

NOTE:

If the speaker is set to **LARGE**, the output level will be higher than that of **SMALL**.

If the speaker is set to **SMALL**, the output level will be lower than that of **LARGE**.

If a speaker is set to **OFF**, no audio is outputted from it.

2.1.3 DIALOG

When **DOWNMIX** is set to **LT/RT** or **STEREO**, this item is available.

Adjust the value of this item to control the dialog volume.

NOTE: When playing 5.1CH disc, this item can be used to adjust the volume of the speakers.

2.1.4 D.R.C. (Dynamic Range Control)

You can set this item to **AUTO**, **ON** or **OFF**.

2.2. DIGITAL AUDIO SETUP

2.2.1 DIGITAL OUTPUT

SPDIF OFF: There will be no digital audio signal output. (Coaxial off)

SPDIF RAW: The digital audio signal output will be in its raw format.

SPDIF PCM: The digital audio signal output will be in PCM format.

2.2.2 LPCM OUTPUT

When **DIGITAL OUTPUT** is set to **SPDIF PCM**, this item is available.

Select a sampling rate for the digital audio output. There are two options, 48KHz and 96KHz.

NOTE: Some amplifiers don't support 96KHz sampling which will affect the coaxial output.

System Setup

2.3 DOLBY DIGITAL SETUP

2.3.1 DUAL MONO

STEREO: The player outputs the left channel audio and right channel audio via the FL and FR speaker respectively.

L-MONO: The player outputs the left channel audio only via both the FL and FR speaker.

R- MONO: The player outputs the right channel audio only via both the FL and FR speaker.

MIX- MONO: The player outputs the average signal of the left channel and right channel audio via the FL speaker and the FR speaker

NOTE: This function only applies to the Dolby AC 3 encoded 2 channel discs.

2.3.2 DYNAMIC

When you watch films with large dynamic scope in low volume, for example at night, you can adjust the dynamic value up to avoid losing sound details resulting from the low volume.

2.4 CHANNEL DELAY

This item is used to set the delay time for the center, rear speakers and the subwoofer. The delay is to compensate for the audio propagation time difference caused by the distance difference of the speakers to the listener.

Use the direction key [↑]/[↓] to select a speaker, center speaker, subwoofer, left surround speaker or right surround speaker. Then use the direction key [←]/[→] to set the distance difference.

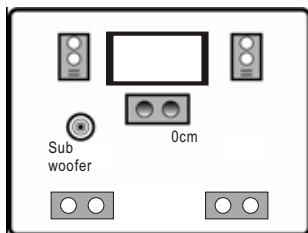

NOTE:

The unit does not support delays for when the distance between the center or surround speakers and the listener are longer than that between the front speakers and the listener. In case the channel delay settings cannot match your speaker configuration, please set all distance difference to 0cm.

2.5 EQUALIZER

2.5.1 SOUND MODE

Select a sound mode in this item.

2.5.2 BASS BOOST

Set it to **ON** to boost the bass sound.

2.5.3 SUPER BASS

Set it to **ON** to get the super bass sound effect.

2.5.4 TREBLE BOOST

Set it to **ON** to boost the treble sound.

2.6 3D PROCESSING

3D processing provides a virtual surround sound experience using just two speakers.

2.6.1 PRO LOGIC II

Pro Logic II: This unit allows you to configure Dolby ProLogic II to expand 2 channel source audio into full 5.1 channel surround sound.

NOTE: Pro Logic II functionality is effective only when **DOWNMIX** is set to **5.1CH** and **DIGITAL OUTPUT** is set to **SPDIF RAW**.

2.6.1.1 PRO LOGIC II

This item is used to turn on or off the ProLogic II processing.

ON: Pro Logic II processing is always on.

OFF: Pro Logic II processing is disabled

AUTO: Pro Logic II processing is on only when Dolby Pro Logic II encoded content is detected.

NOTE: When the ProLogic II processing is turned off, all the following items (**MODE**, **PANORAMA**, **DIMENSION** and **CENTER WIDTH**) are unavailable.

2.6.1.2 MODE

This item is used to set the processing mode of Pro Logic II.

MUSIC: The surround experience is tailored for multi channel music playback.

MOVIE: Emphasis is given to the center channel as two channel audio is decoded and played back into your 5.1 system.

PRO LOGIC: This activates decoding and processing of the original Dolby Pro Logic processing with mono surround channel. We recommend using the Dolby Pro Logic Movie mode in lieu of this 4 channel surround format.

AUTO: Automatically selects processing mode based on the input format.

2.6.1.3 PANORAMA

This item is used to turn on/off panorama mode and is available only when **MODE** is set to **MUSIC**.

When panorama mode is turned on, the front stereo audio is partially fed into the surround channels for an enveloping effect.

2.6.1.4 DIMENSION

This item is available only when **MODE** is set to **MUSIC**.

This item allows gradual adjustment of the sound field either towards the front or towards the rear. This is useful in setting a more even balance from all speakers with some rooms.

2.6.1.5 CENTER WIDTH

This item is available only when **MODE** is set to **MUSIC**.

This item can be used to control the width of the center channel sound effect by blending the center speaker to the left and right speakers. As the level number increases, the center channel sound moves toward the left and right speakers.

2.6.2 REVERB MODE

You can select a reverb mode in this item.

System Setup

2.7 HDCD(High Definition Compatible digital)

HDCD (High Definition Compatible digital) is a patented encode/decode process for delivering the full richness and details of the sound from HDCD encoded CDs.

2.7.1 FILTER

You can select the digital filter at 2x, 1x or off.

3 VIDEO SETUP PAGE

3.1 VIDEO OUTPUT

S-VIDEO: Set video output to S Video if the S Video connection is made.

YCbCr: Set video output in analog component video format if the component video outputs are used.

YPbPr: Set video output as progressive YUV signals if the component video outputs are used.

NOTE: If the video setting differs from the physical video connection, the TV set may have no picture. You can press [V MODE] on the remote control repeatedly to switch to an appropriate video output mode.

3.2 COLOR SETTING

3.2.1 SHARPNESS

There are three options (**HIGH**, **MEDIUM** and **LOW**) for you to choose in this item.

3.2.2 BRIGHTNESS, CONTRAST, HUE and SATURATION

Enter these items respectively, use direction key [←]/[→] to adjust the value, then press [ENTER] to confirm it.

3.2.3 GAMMA

There are four options (**HIGH**, **MEDIUM**, **LOW** and **NONE**) for you to choose in this item.

3.2.4 LUMA DELAY

There are two options (**0T** and **1T**) for you to choose in this item.

4 PREFERENCE PAGE

If there's no disc in the disc tray, the disc tray is open or the disc in the disc tray is stopped, this item is available.

4.1 TV TYPE

This product supports both NTSC (National Television System Committee) and PAL (Phase Alternating Line) television broadcasting standards.

PAL: If the connected TV is PAL system, select this mode. The video signal of a NTSC disc will be output in PAL format.

MULTI: If the connected TV is multi system, select this mode. The output format of video signal will be in accordance with the video signal of the disc.

NTSC: If the connected TV is NTSC system, select this mode. The video signal of a PAL disc will be output in NTSC format.

NOTE: If a wrong selection is made, the viewing image will be very poor. In such case, you are supposed to change the option in this item to fix the error.

4.2 PBC (Play Back Control)

ON: Activate the PBC function.

OFF: Disable the PBC function.

You can also press [MENU] to activate/disable the PBC function.

NOTE: This function only works with those discs encoded with PBC function such as VCD 2.0, SVCD, etc.

DVD, VCD 1.1, CD DA and MP3 disc have no PBC menu.

4.3 AUDIO, SUBTITLE and DISC MENU

Select a preferred audio language, subtitle language and disc menu language in these items. You can also make selection of the audio language by using the [AUDIO] and the subtitle language by the [SUBTITLE] on the remote control.

NOTE: If the selected language is not available for the currently playing disc, the disc's default audio, subtitle, disc menu language setting works.

4.4 PARENTAL

This item allows the user to set a maximum rating of the movies that can be viewed. Movies rated higher than the set level can not be viewed without inputting the correct keywords. What's more, to key in the correct password is needed to reset the level. The default password is 136900.

NOTE: This function only works with those discs with parental function.

4.5 DEFAULT

Restore all the default settings except the settings in **PARENTAL** item and **PASSWORD SETUP PAGE**.

5 PASSWORD SETUP PAGE

5.1 PASSWORD MODE

You can switch on/off the password function in this item.

NOTE: You must key in the correct password and press [ENTER] to confirm before you change the option in this item. The default password is 136900.

5.2 PASSWORD

You can reset the password in this item.

NOTE: The default password (136900) is always active even if the password has been reset. So if you forget your reset password, use it.

Basic Playback

USB DRIVE PLAYBACK

● Insert a USB drive in the USB port, then press [USB] to enter the connected USB drive and you can playback the readable files in it. Press [USB] again to switch back to DVD mode.

NOTE:

● In case the player breaks down when you insert a USB drive into the player, turn off the player, disconnect the power cord from the AC outlet and unplug the USB drive from the player. Then, power on the player again. The player will resume the normal status. The connected USB drive is probably not a certified one. The player cannot play any uncertified USB drive.

● For playback operation, please refer to **MP3 DISC PLAYBACK** in this chapter.

USB MEMORY DEVICE OPERATION

● IMPORTANT INFORMATIONS ●

- Copyright protection files cannot be played back.
- Copyright protection files on the USB memory device are skipped automatically when played back.
- Recommended use:
Flash memory type USB memory player
- Not recommended:
Hard disc memory type USB player
- Some Flash memory player will not play successfully with this unit.

Load a Disc

Press [OPEN/CLOSE] to open the disc tray. Insert a disc with the label side up, then press [OPEN/CLOSE] again to close the disc tray.

If a single sided disc is inserted upside down, the disc tray will open automatically; if not, the unit will display "NO DISC".

MP3 DISC PLAYBACK

Insert an **MP3 disc** into the player, then a content menu will display on the screen.

MENU OPERATION:

Use the direction key [↑]/[↓] to select a folder or a file, then press [ENTER] to enter the selected folder or play the selected file. You can also use the digit keys to make selection of a folder to enter a file to play.

In the content menu, press [←] to return to the upper menu; press [◀]/[▶] to turn over to the previous/next the menu page.

[PROG]: Press repeatedly to switch between **FOLDER mode** and **FILELIST mode**.

NOTE: During playback, [◀], [▶], [▶], [⏸], [■] (press to stop the playback), [REPEAT], [A/B], [VOLUME+/-], [MUTE], etc. are valid. Please refer to the remote control function introduction for details.

PICTURE CD PLAYBACK

● Place a **picture CD** in the disc tray, then the unit will load the disc automatically (the maximum size of the picture should be less than 8900*8900 pixels).

● Press [■] to enter the thumbnail mode to preview the pictures.

In the thumbnail mode, use the direction keys to select a picture, then press [ENTER] to start the playback from the selected picture.

In the thumbnail mode, use the direction keys and [ENTER] to make selection of **Slide Show, Menu, Prev** or **Next** at the bottom of the screen.

Slide Show: Start slideshow playback.

Menu: Enter the instruction menu for remote key function. In the menu, press [ENTER] to turn over to the next menu page and again to exit the instruction menu.

Prev/Next: Turn over to the previous/next page.

● Remote key function introduction:

[PROG]: Switch the transition effects (wipe top, wipe bottom, wipe left, wipe right, etc.)

[■]: Enter the thumbnail mode to preview the pictures.

[ZOOM]: During playback, press [ZOOM], then press [▶]/[◀] to zoom in/out the picture.

When the picture is zoomed in, the direction keys can be used to move the picture. Press [ZOOM] again to exit the zooming mode.

[◀◀]/[▶▶]: Press to skip to the previous/next picture during playback.

[||]: Press to pause a playback. Press again or press [▶] to resume the playback.

[▶]: Press to start a playback or resume to the normal playback.

[←]/[→]: Press to rotate the picture counterclockwise/ clockwise during the playback.

[↑]/[↓]: Press to create a vertical/horizontal mirror image.

MP3/CD OPERATION

● IMPORTANT INFORMATIONS ●

- Copyright protection files cannot be played back.
- Copyright protection files on a disc are skipped automatically when played back.

Troubleshooting

Before resorting to maintenance service, please kindly check by yourself with the following chart.

Symptom	Cause(s)	Remedy
No Power	<ul style="list-style-type: none"> ● The AC power cord is not connected to the power supply or is not connected to a power supply securely. 	<ul style="list-style-type: none"> ● Please check that the AC power cord is connected securely.
Picture There is no picture or the picture is distorted.	<ul style="list-style-type: none"> ● The video cable isn't connected securely. ● Video output mode of the unit isn't correctly set. ● Video input mode of the connected TV isn't correctly set. 	<ul style="list-style-type: none"> ● Connect the video cable securely. ● Press [V MODE] repeatedly until the picture becomes normal again. ● Set an appropriate video input mode.
Sound There is no sound or the sound is distorted.	<ul style="list-style-type: none"> ● The audio cables aren't connected securely. ● The volume is set to the minimum level. ● The sound is switched off. ● The disc is in fast forward/reverse playback. 	<ul style="list-style-type: none"> ● Connect the audio cables securely. ● Turn up the volume. ● Press [MUTE] on the remote control to switch on the sound. ● Press [PLAY].
Unable to play a disc	<ul style="list-style-type: none"> ● This disc is placed in the disc tray in a wrong way. ● The rating of the disc is higher than the rate set in the parental control item. ● The unit isn't compatible with the disc. ● The disc is dirty. 	<ul style="list-style-type: none"> ● Check that the disc is placed in the disc tray with its label side upwards. ● Reset the settings in the parental control item. ● Place the compatible disc. ● Clean the disc.
The player breaks down when a USB drive is inserted into the player.	<ul style="list-style-type: none"> ● The connected USB drive is probably not a certified one. 	<ul style="list-style-type: none"> ● The player cannot play any uncertified USB drive. <p>In case the player breaks down, turn it off, disconnect the power cord from the AC outlet and unplug the USB drive from the player. Then, power on the player again. The player will resume the normal status.</p>
The buttons on the unit doesn't work.	<ul style="list-style-type: none"> ● The unit is being interfered with static electricity etc. 	<ul style="list-style-type: none"> ● Switch off and unplug the unit. Then connect the plug to the power supply and switch it on again.
The remote control does not function.	<ul style="list-style-type: none"> ● There is no battery in the remote control. ● The batteries are out of charge. ● The remote control isn't pointed to the remote sensor. ● The remote control is out of its operating area. ● The unit is shut down. 	<ul style="list-style-type: none"> ● Install two AAA/1.5V batteries in it. ● Replace the batteries with new ones. ● Make sure that the remote control is pointed to the remote control sensor. ● Make sure the remote control is within the operating area. ● Switch off the unit and disconnect it from the AC outlet. Then power on the unit again.

Specifications

Power supply	AC~100-240V/50-60Hz
Power consumption	Less than 20W
TV system	PAL/NTSC
Laser wave length	DVD: 650nm CD: 780nm
Laser power output	180 μ W
Audio frequency range	DVD: 4Hz~22kHz (48kHz PCM) 4Hz~44kHz (96kHz PCM) CD: 4Hz~20kHz
S/N ratio	\geq 80dB
Audio dynamic range	\geq 90dB
Operating conditions	Temperature: 0~40°C, operated horizontally
Composite Video output	1.0V (P-P) , 75 Ω
Component Video output	(Y) 1.0V(P-P),75 Ω (Cb) 0.7V(P-P),75 Ω (Cr) 0.7V(P-P),75 Ω
S-video output	(Y) 1.0V(P-P),75 Ω (C) 0.286V(P-P),75 Ω
Audio output (analog audio)	2.0V(rms)
Dimension of the main unit	360x215x35mm
Weight of the main unit	1.4Kg



SANYO Electric Co., Ltd.

Made in China